

STUDER REVOX

# B795

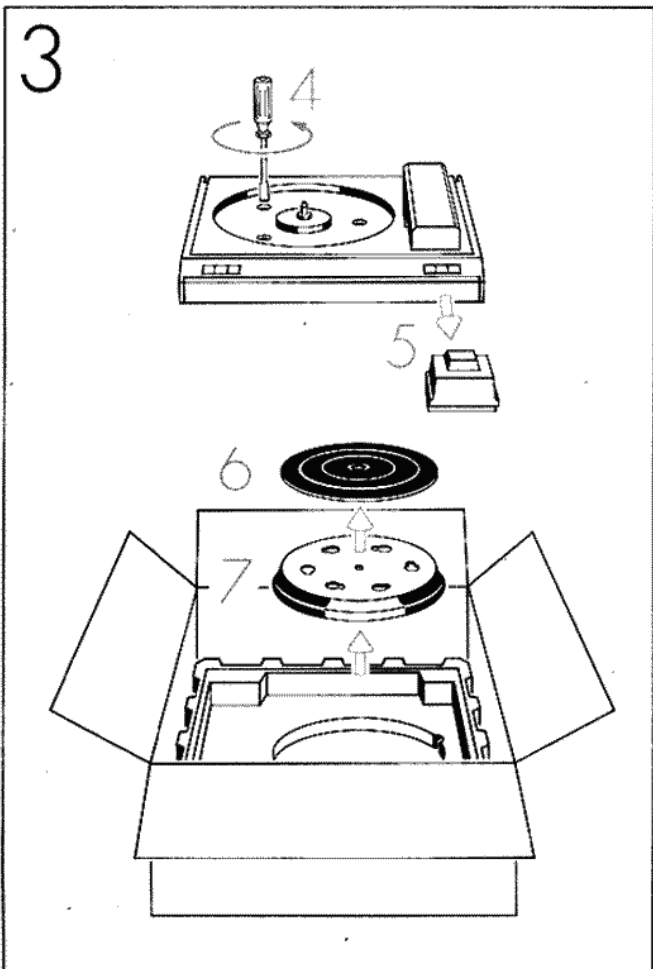

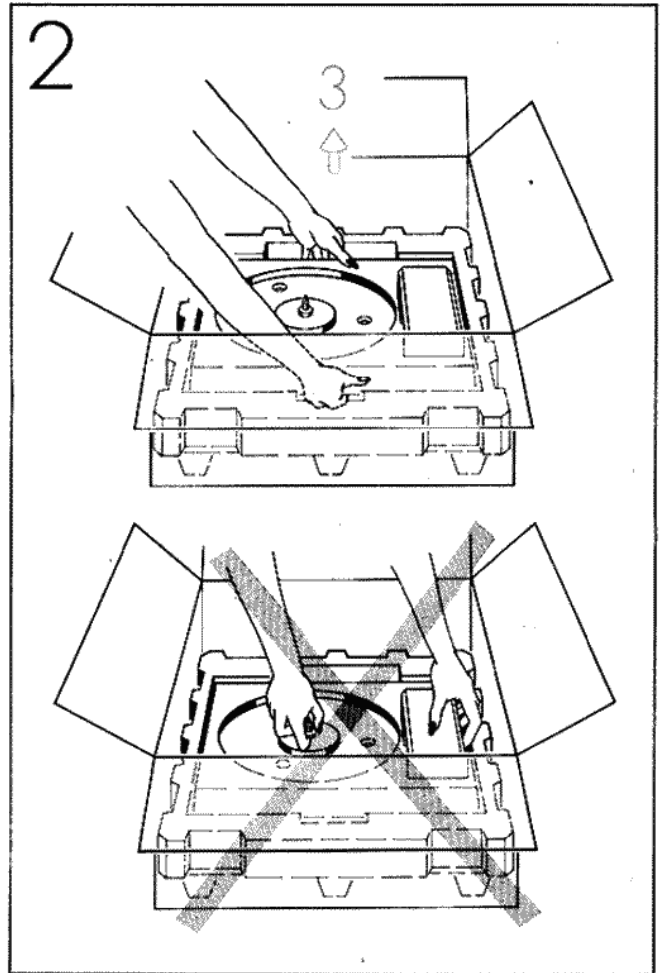

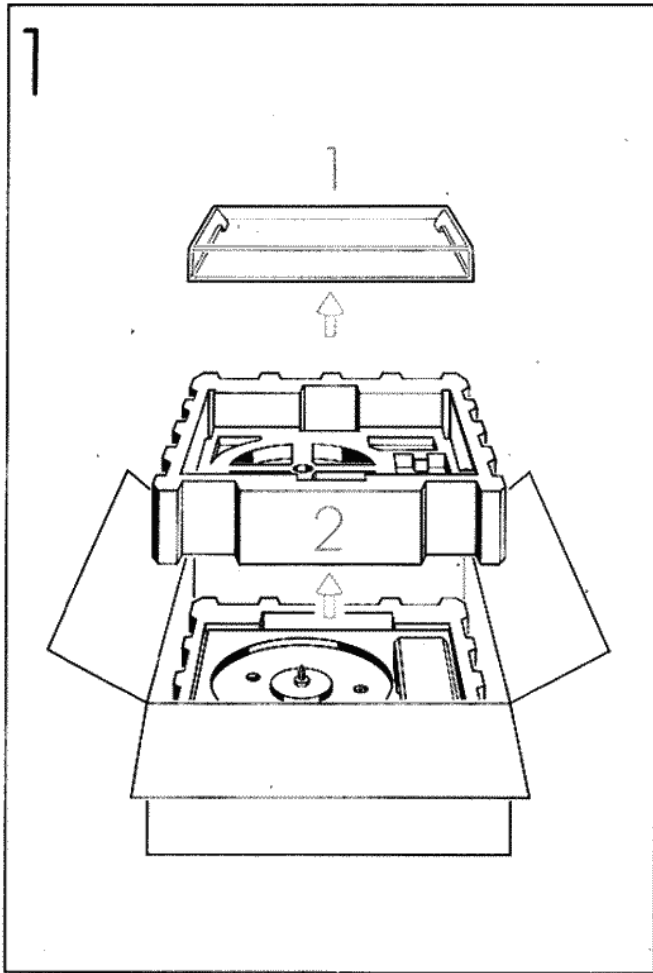

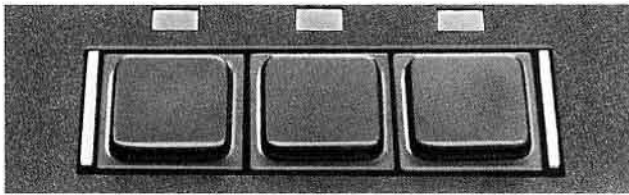

POWER 33 45

Push button POWER  
Push button "33"  
Push button "45"

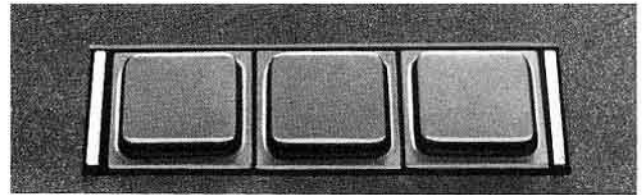

◀ ▼▲ ▶

Push button ◀ inward movement  
Push button ▼▲ lowering/lifting  
Push button ▶ outward movement

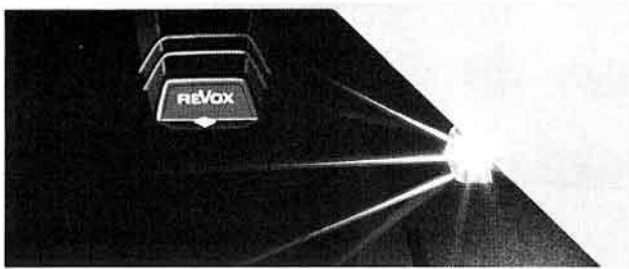

Phono cartridge / Stylus unit  
Stylus illumination

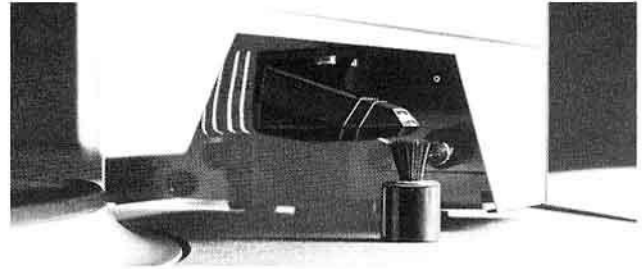

Stylus brush

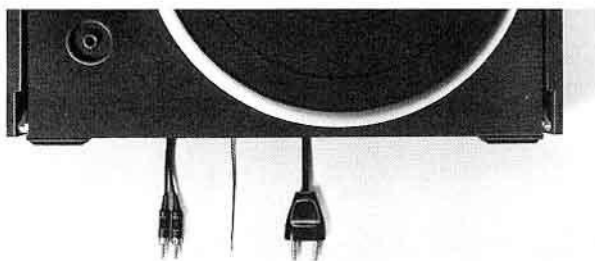

45-rpm adapter  
Audio cables  
Ground wire  
Power cord



Electrical fuse

---

## IMPORTANT NOTES

Protect your turntable from excessive heat and humidity. Install it in a manner which ensures the free convection of air through the ventilating louvers.

There are no user serviceable parts inside the equipment, however, should it become necessary to open the turntable, it must first be disconnected from the electrical current supply. Be sure to connect the unit to AC (50... 60 Hz) mains supplies only. For operation on different supply voltages, a wire jumper on the power transformer has to be

resoldered to cover the nominal voltages of 100/110/120 V or 200/220/240 V.

Before putting the equipment into operation, do not forget to loosen the three transport screws (figure 3, inner page of the cover).

---

## WARRANTY

For equipment purchased in Belgium, the Federal Republic of Germany, Austria and France a special warranty application card is either contained in a plastic envelope attached to the outside of the packing carton or is enclosed with the equipment. If this card is missing, please request it from your dealer. Complete the warranty application card and return it to your national distributor who will then send you your warranty card.

For equipment purchased in Switzerland, the warranty responsibility rests with your dealer. Please note that the warranty is not valid outside the country of purchase.

The warranty will be voided if the unit is tampered with or serviced by unauthorized personnel.

---

## PACKING MATERIAL/TRANSPORT

Do not destroy the original packing. If you ever have to transport your equipment, this special packing will provide the best possible protection for your valuable turntable.

When transporting the turntable gently tighten the three transport screws (figure 3, inner page of the cover).

# OPERATING CONTROLS AND ELECTRICAL CONNECTIONS

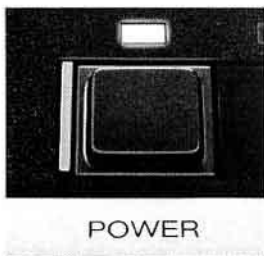

## Push button POWER

By pressing this push button, the electric current supply is switched on. The pilot light POWER becomes luminous. By pressing this push button a second time, the electric current supply will be switched off again.

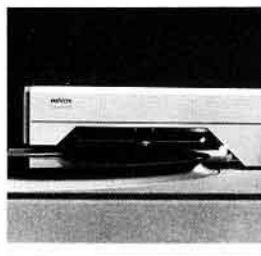

## Linatrack® tone arm support

Turn the swivelled tone arm support over the disk on the platter. Located underneath the cover of the tone arm support is the just 1½ inch (40 mm) long linear tracking tone arm.

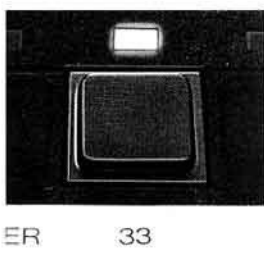

## Push button "33"

The operation of this button selects the quartz referenced platter speed of 33.33 rpm. The Light Emitting Diode (LED) above this button becomes luminous when the platter has reached its nominal speed.



## 45-rpm adapter

This adapter is provided for the playing of 45 rpm records (singles) with large center hole.

ER 33

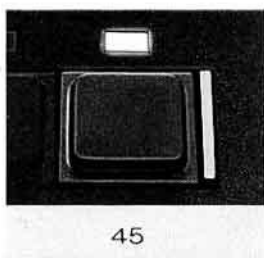

## Push button "45"

The operation of this button selects the quartz referenced platter speed of 45.00 rpm. The LED above this button becomes luminous when the platter has reached its nominal speed.

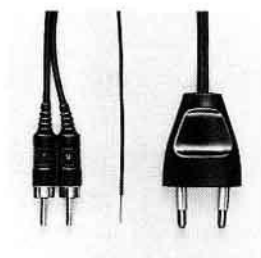

## Audio cables

The cables are equipped with phono plugs for connecting to the phono input of the amplifier. The plugs are marked with "L" for the left channel and "R" for the right channel.

45

## Ground wire

## Power cord

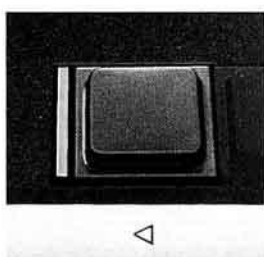

## Push button ◀ inward

By pressing this button, movement of the cartridge towards the center of the turntable is effected, provided the arm support is swung into its operating position. A slow movement is effected by just tapping the button, continuous pressing will result in rapid movement.



## Pick-up cartridge in the linear tracking tone arm

The cartridge is factory adjusted. If you intend to install another cartridge, enquire at your dealer about the availability of the required installation kit.

◀

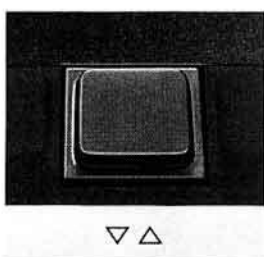

## Push button ▼▲ lowering/lifting

The operation of this button enables the lowering or lifting of the cartridge at any desired point of a record.



## Stylus brush

Wipes off dust particles from the stylus when swivelling the arm support into the operating position.

▼ ▲

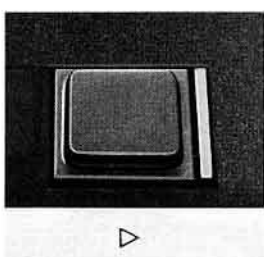

## Push button ▶ outward

By pressing this button, movement of the cartridge towards the rim of the turntable is effected, provided the arm support is swung into its operating position. A slow movement is effected by just tapping the button, continuous pressing will result in rapid movement.



## Fuse

100...120 V: 0,4 AT slow-blow  
200...240 V: 0,2 AT slow-blow

▶

## PUTTING THE TURNTABLE INTO OPERATION



### Audio connections

Connect the audio cables to the phono input of your amplifier/receiver.

L = left channel

R = right channel

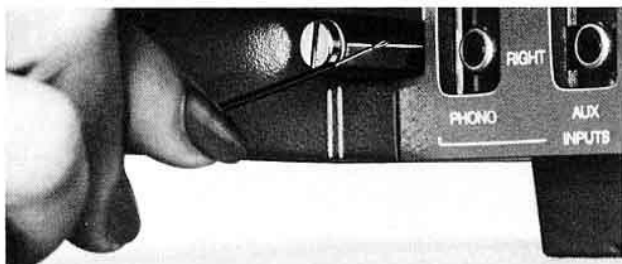

### Ground wire

To avoid hum interference, connect the ground wire to the ground terminal (screw) on your amplifier/receiver.



### Power cord

Connect the power cord to the AC power outlet.

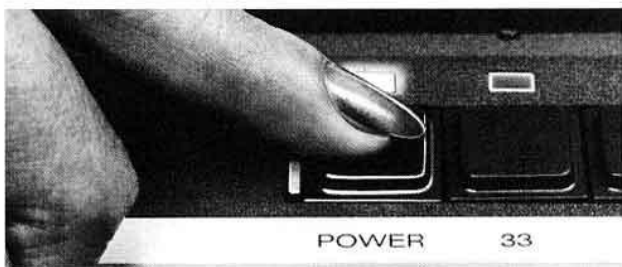

### Switching on

Press button POWER to switch the turntable on.

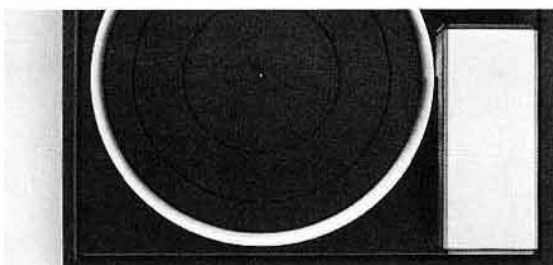

### Swivelled tone arm support

In its rest position the swivelled tone arm support points forward; it is swung away from the platter. In this position the tone arm controls ◀, ▼▲, ▶ are ineffective.

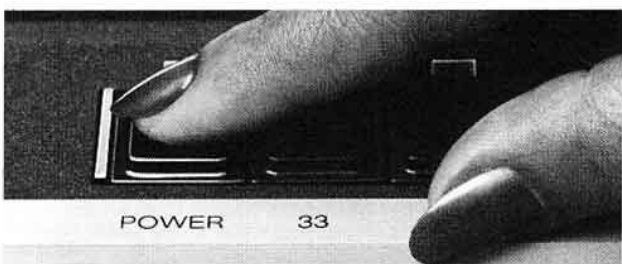

### Switching off

To switch off the turntable, press the button POWER.

## OPERATION

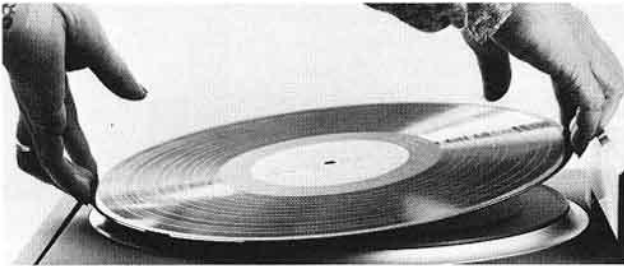

### Playing a 33-rpm record

Place the record onto the platter and press the button "33".

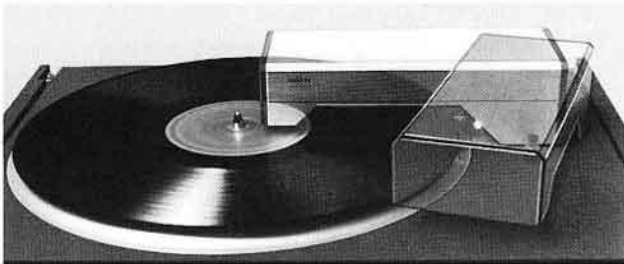

Swivel the tone arm support over the record until it locks into a detent. The stylus illumination will thus be switched on automatically and the platter begins to rotate. As soon as the platter has reached nominal speed the LED 33 becomes luminous.

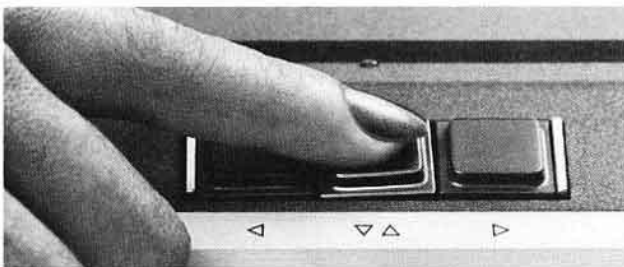

Press button ▼▲ lowering. The tone arm lowers itself onto the record and the stylus illumination is switched off automatically.



### Playing a 45-rpm record

If the record possesses a large center hole, first place the adapter and then the record onto the platter. Swivel the arm support over the record until it locks and press button "45".

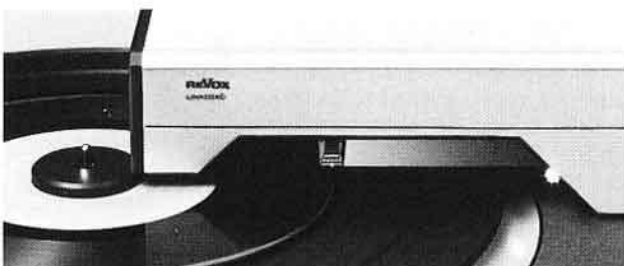

Press the button ◀ (inward) and keep it depressed until the tone arm has been transported over the record's run-in groove.

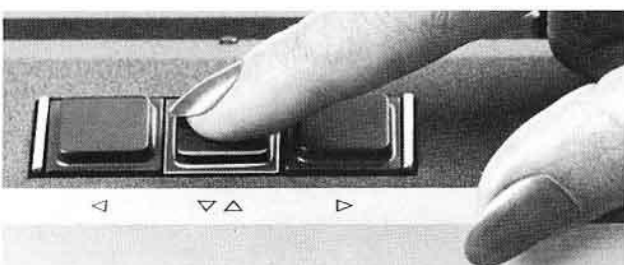

Press button ▼▲ (lowering). At the end of the record, the arm will lift and return automatically to its start position.



## GENERAL

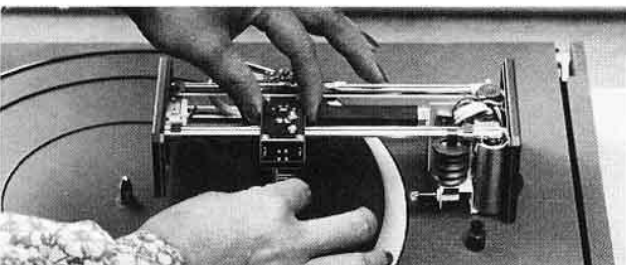
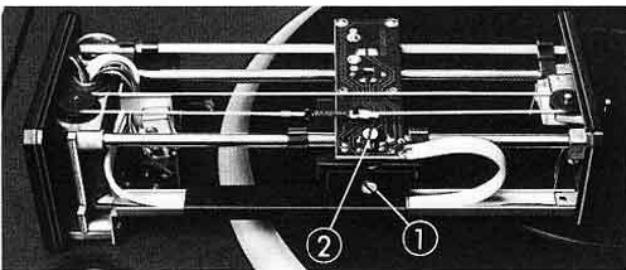
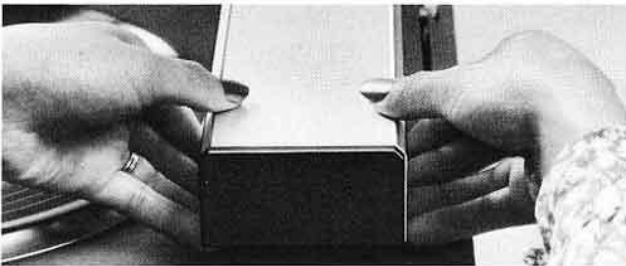
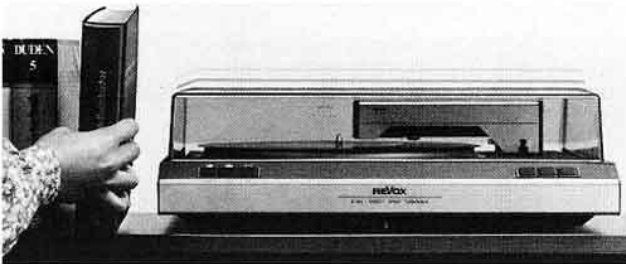
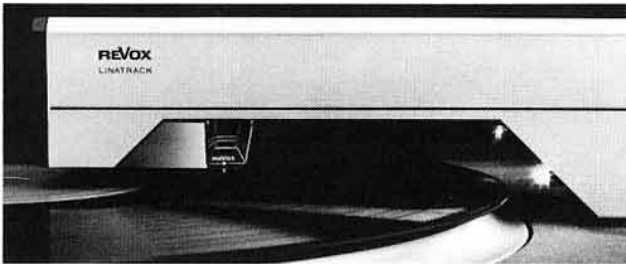

### Tone arm control

When the tone arm has reached the end of a record (run-out groove) it gets transported automatically to its start position. This sequence may be interrupted by pressing the button ◀.

The buttons ◀ and ▶ may be pressed at any time, even in the midst of playing. They effect automatic lifting of the arm followed by its transportation in the desired direction.

### Automatic control functions

When reaching a record's run-out groove or when swivelling the tone arm support away from a playing record, lifting of the tone arm is effected and this is followed immediately by its return to the start position. After the tone arm has arrived at its start position the platter motor becomes switched off. By pushing the button ▼▲ playing can be initiated again at any time. The design of the tone arm and the floating chassis is highly insensitive to vibrations and mechanical shocks.

### Removal of cover from the arm support

For removing the cover from the arm-support, first transport the cartridge to a half-way position then switch off the electric current supply. Swivel the arm-support away from the platter to its rest position. Reach under the sides of the cover and while gently pulling the sides outwards lift the cover away from the arm-support.

### Tracking force/limit of vertical movement

Tracking force is optimized by factory adjustment (screw ①).

Vertical movement is also limited by factory adjustment (screw ②). The stylus can not touch the rubber mat.

Should adjustments become necessary follow the instructions supplied with the REVOX installation kit.

### Stylus replacement

First remove the cover from the arm-support. With thumb and index finger of one hand take a firm grip on the black part of the cartridge and carefully pull off the stylus unit with your other hand.

When inserting the new stylus unit hold the black part of the cartridge firmly while carefully pushing the stylus unit into place.

### Replacing a blown fuse

To replace the fuse, the turntable must first be disconnected from the electric current outlet. Next, lift off the platter from the drive motor and tighten the three transport locking screws. Lift complete turntable on one side to make it stand on the opposite side. Unscrew the fuse cap and replace the defective fuse. The required fuse ratings are listed in the technical data section. After replacement of the fuse, proceed in reversed order of the steps described above to make the unit operational again.

---

## TECHNICAL DATA

|                                      |  |   |   |
|--------------------------------------|--|---|---|
| <b>Turntable drive:</b>              | Quartz referenced direct drive   | <b>Phono cartridge:</b>                       | REVOX P20 MDR   |
| Turntable speeds:                    | 33.33 and 45.00 rpm  | Frequency response:                           | 20 Hz...20 kHz +3/-1 dB   |
| Speed accuracy:                      | 0.01%  | Channel balance (1 kHz):                      | better than 2 dB  |
| Platter (Turntable proper):          | Diameter 12.32 inches (313 mm)   | Channel separation:                           | better than 25 dB at 1 kHz  |
| Weight (Mass):                       | 4 lbs. 10 ozs. (2.1 kg)  | Compliance:                                   | 40 $\mu$ m/mN (static value at recommended tracking force)  |
| Run up time:                         | better than 2 seconds at 33.33 rpm   | Trackability (at 300 Hz):                     | better than 85 $\mu$ m at 12.0 mN (1.2 grams)   |
| Braking time:                        | better than 2 seconds from 45 to 33.33 rpm   | Recommended tracking force:                   | 12.0 mN (1.2 grams), factory set  |
| Wow and flutter*:                    |  | Stylus tip radius:                            | 5 x 18 $\mu$ m elliptical, nude diamond   |
| weighted:                            | better than 0.05%  | Signal to noise ratio:                        | better than 65 dB   |
| linear:                              | better than 0.1%   | Recommended load:                             | 47 kohms/470 pf (220 pf already in cable)   |
| Rumble to signal ratios**:           | better than 48 dB (DIN 45539 A weighting)<br>better than 50 dB (DIN 45539 A weighting plus 20 Hz high pass)<br>better than 70 dB (DIN 45539 B) | <b>Operating controls:</b>                    |   |
|                                      |  | Turntable drive:                              | 2 tactile feedback keys for 33.33 and 45 rpm, 1 power switch  |
| <b>Tone arm:</b>                     | linear tracking tone arm with servo-electronic follow-up control   | Tone arm:                                     | 3 tactile feedback keys for fast inward or outward movement plus lowering and lifting of the pick-up cartridge; built-in stylus illumination. |
| Lateral tracking angle error:        | less than 0.5°   | <b>General:</b>                               |   |
| Skating compensation:                | not required with a linear tracking system   | Components list:                              | 21 IC's, 19 transistors, 29 diodes, 4 LEDs, 2 bridge type rectifiers  |
| Tracking force:                      | adjustable from 8...20 mN (0.8...2 g)  | Electric current supply (solder connections): | 100/110/120 V + 10%, 200/220/240 V + 10%<br>50...60 Hz  |
| Tone arm lowering:                   | electronically controlled, pneumatically damped  | Fuse:   | 100...120 V: 0.4 A slow-blow<br>200...240 V: 0.2 A slow-blow  |
| Muting:                              | electronically muted until the stylus has contacted the disc   | Weight:                                       | 20 lbs. 1 oz (9.1 kg)   |
| Tone arm follow-up:                  | Opto-electronic sensing with LED as light source, servo electronics and DC motor   | Dimensions (W x H x D):                       | 17.7 x 5.6 x 15.6 inches (449 x 142 x 395 mm)   |
| Run-out switch:                      | Automatically activated via servo-electronics  | Dust cover closed:                            | height 13.4 inches (340 mm)   |
|                                      |  | Dust cover open:                              |   |
| <b>Automatic functions:</b>          |  |   |   |
| Swivelling the tone arm support in:  | turntable platter starts to rotate at the selected speed   |   |   |
| Swivelling the tone arm support out: | a) immediate lifting of the cartridge<br>b) tone arm returns to start position<br>c) turntable stops, stylus illumination switched off         |   |   |

\*measured with IEEE 193-1971 weighting and an optimally centered, direct cut laquer, L+R

\*\*all rumble measurements taken in position "mono" with a statically discharged disc and the "new" RIAA reproduce equalization.

---

## THE REVOX PRODUCT RANGE

REVOX offers a complete range of hi-fi system components. They may be used together with your model B795 turntable in any desired combination:

REVOX B77 tape-recorder

REVOX B750 integrated amplifier

REVOX B760 digital synthesizer FM tuner

REVOX B780 microprocessor synthesizer

FM receiver

Ask your dealer for the REVOX full-line catalog.

## TURNTABLE DRIVE ELECTRONICS

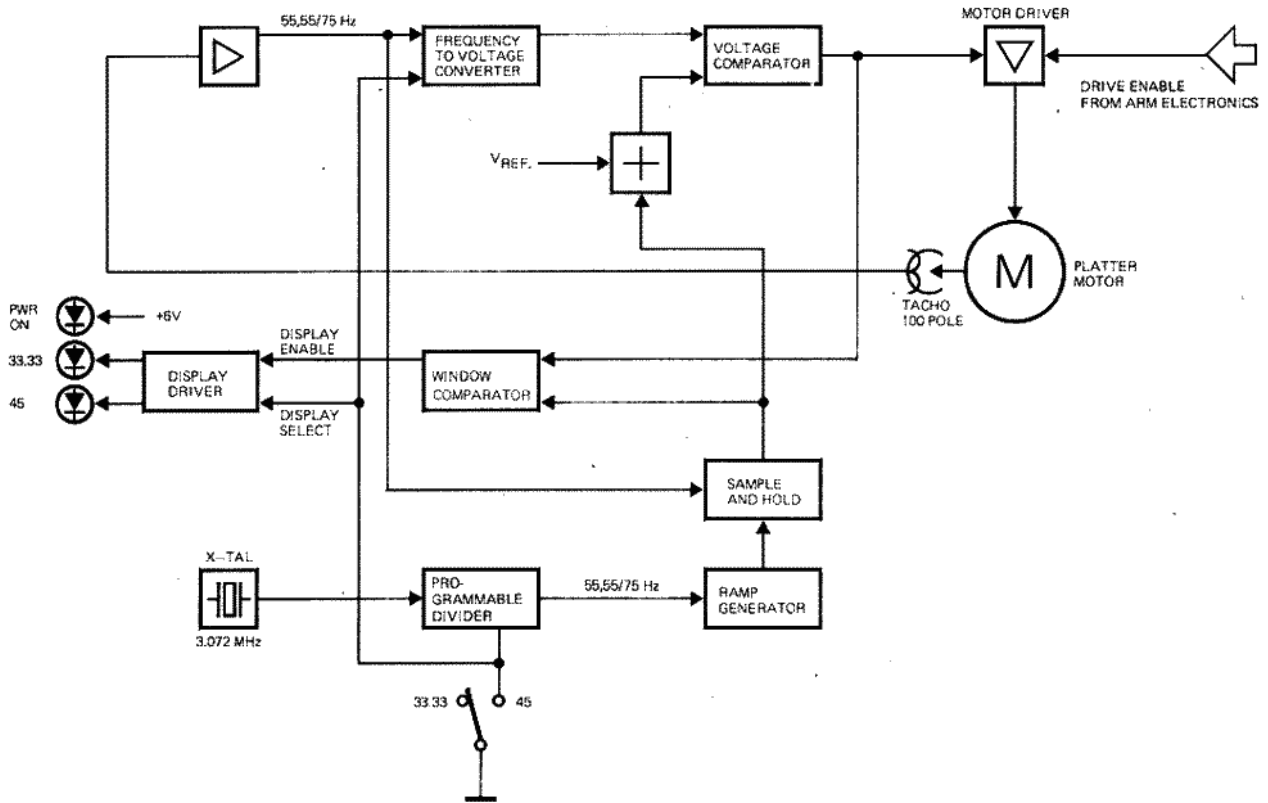

## TONE ARM ELECTRONICS

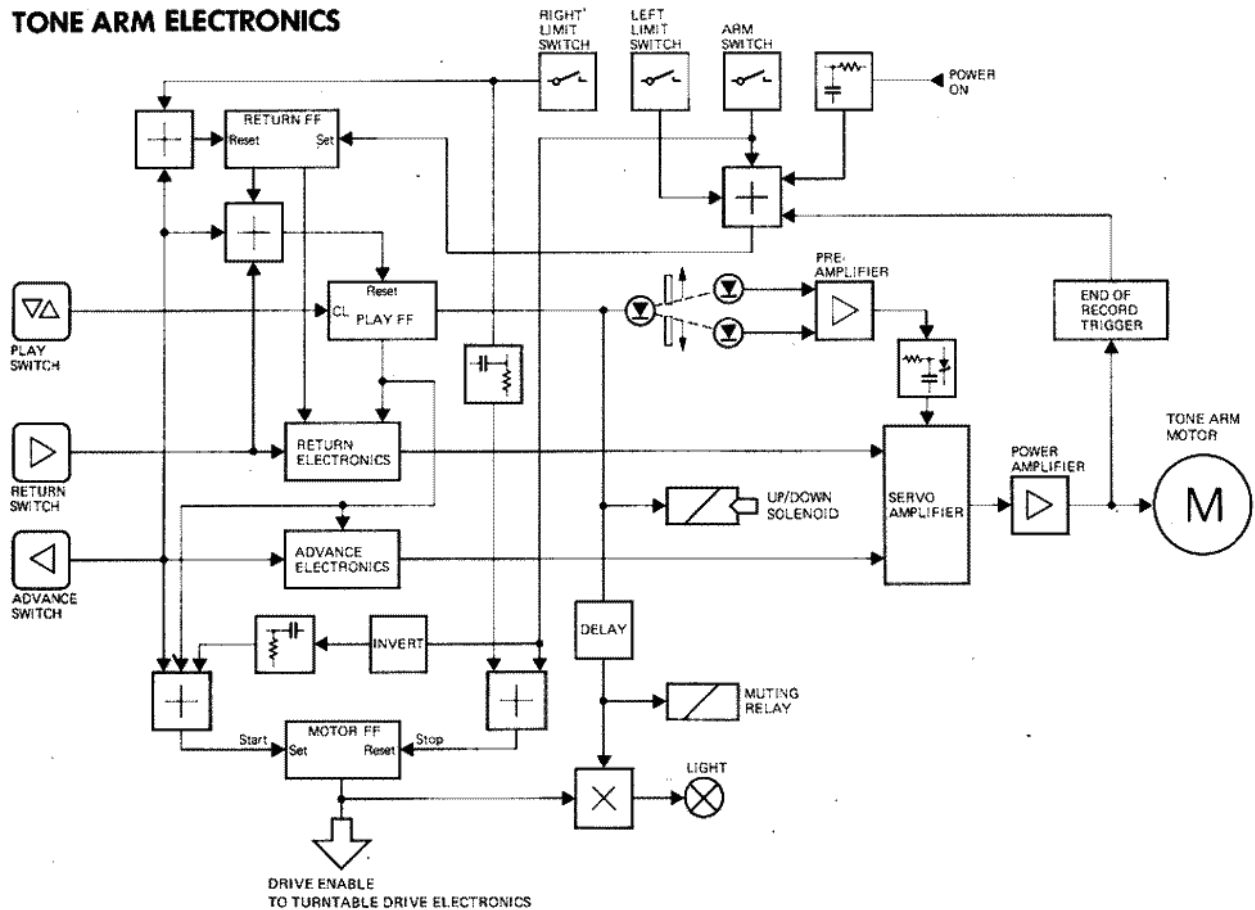

**Manufacturer**

WILLI STUDER  
CH-8105 Regensdorf/Switzerland  
Althardstrasse 30

WILLI STUDER GmbH  
D-7827 Löffingen/Germany  
Talstrasse 7

**Worldwide Distribution**

REVOX ELA AG  
CH-8105 Regensdorf/Switzerland  
Althardstrasse 146

